

FEATURES

- unique twin average detectors
- dual channel signal processing
- adjustable AGC threshold levels
- MPO range externally adjustable
- handles high input levels (up to 100 mVRMS) cleanly
- designed for CIC instruments
- 2:1 compression of high frequencies
- designed to drive class D integrated receivers
- 65% smaller by volume than DynamEQ® I (GS3011)
- 50% smaller by volume than DynamEQ® I (GS3021)

STANDARD PACKAGING

- Hybrid Typical Dimensions
0.180 in x 0.115 in x 0.080 in
(4.57 mm x 2.92 mm x 2.03 mm)

DESCRIPTION

DynamEQ® I (GS3023) hybrid is a dual channel level dependent input compression amplifier.

This WDRC (Wide Dynamic Range Compression) system can be easily configured to provide either a TILL (Treble Increases at Low Level) or wideband response.

Twin averaging detector circuits drastically reduce the pumping effects associated with traditional fast attack/slow release systems. The fast detection circuitry cuts in to control the output level during impulsive sounds, but quickly backs out of the way during normal operation.

Low distortion, large signal handling capabilities and constant corner frequency make it ideal for providing loudness growth compensation for many of the mild to moderate cases.

The size of the hybrid and variety of electrical access points, offers system design flexibility perfect for ITC and CIC applications.

Stage A is a highpass channel with 2:1 compression, Stage B is a wideband unity gain buffer. The sum of the two paths gives a high frequency boost to low level signals, which gradually compresses to a flat response at high input levels. Stage C is used for volume control adjustment, while stage D is a fixed gain stage with MPO control designed to drive class D integrated receivers.

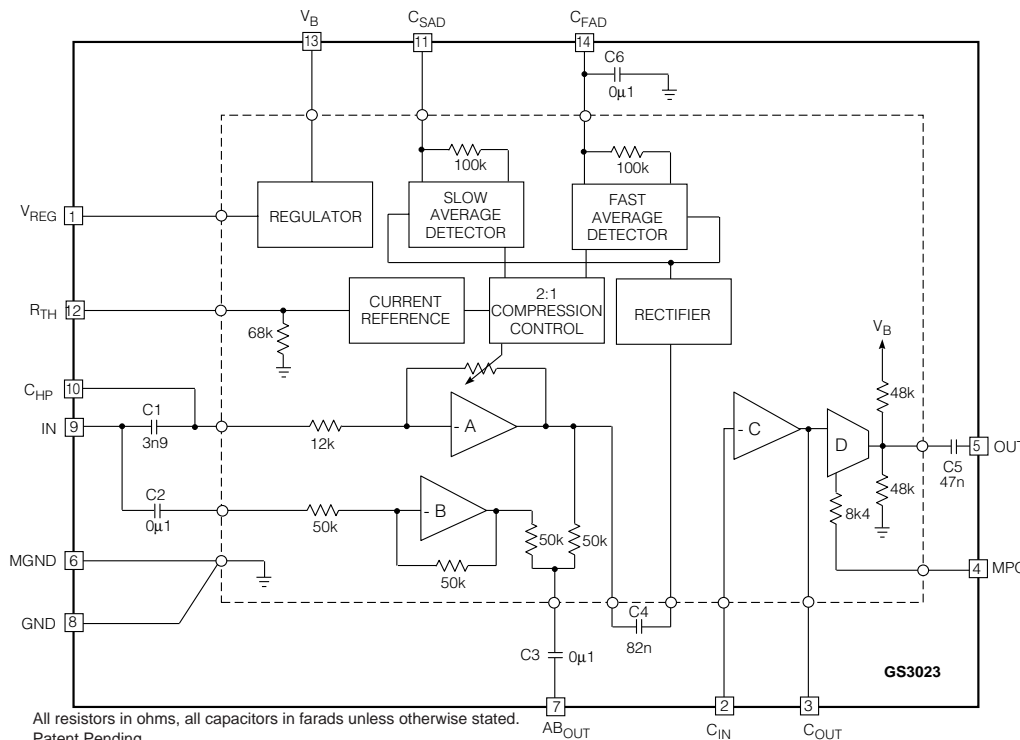

All resistors in ohms, all capacitors in farads unless otherwise stated.
Patent Pending.

FUNCTIONAL BLOCK DIAGRAM

ABSOLUTE MAXIMUM RATINGS

PARAMETER	VALUE / UNITS
Supply Voltage	3 VDC
Power Dissipation	25 mW
Operating Temperature Range	-10° C to 40° C
Storage Temperature Range	-20° C to 70° C

CAUTION
CLASS 1 ESD SENSITIVITY



PAD CONNECTION

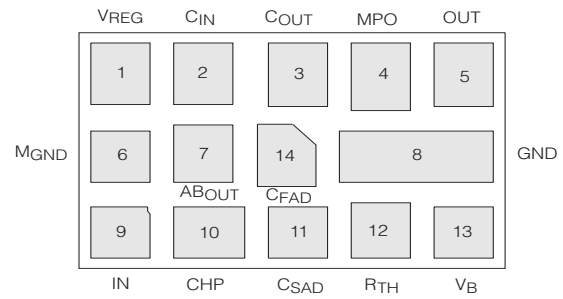

ELECTRICAL CHARACTERISTICS

Conditions: Input Level $V_{IN} = -97\text{dBV}$, Frequency = 5 kHz, Temperature = 25°C, Supply Voltage $V_B = 1.3\text{ V}$

PARAMETER	SYMBOL	CONDITIONS	MIN	TYP	MAX	UNITS
Hybrid Current	I_{AMP}	$V_{IN} = 0\text{VRMS}$, $RMPO = 50\text{k}\Omega$	120	230	380	μA
Minimum Voltage	V_B		1.1	-	-	V
Total Harmonic Distortion	THD	$R_{VC} = 15\text{k}\Omega$; $V_{IN} = -40\text{dBV}$ at 1kHz	-	0.1	1	%
Input Referred Noise	IRN	NFB 0.2 to 10kHz at 12dB/oct	-	2.5	-	μVRMS
Total System Gain	A_V		45	48	51	dB
AGC						
Compression Ratio	COMP	$V_{IN} = -60\text{dBV}$ & -80dBV	1.74:1	1.95:1	2.11:1	Ratio
Threshold			-	-94	-	dBV
Compression Gain Range	A_{RANGE}	$R_{VC} = 10\text{k}\Omega$; Note 1	26	28	-	dB
High Pass Corner Frequency	f_{HPC}	C_{HP} - Not Connected	-	3.4	-	kHz
System Gain in Compression	A_{80}	$V_{IN} = -80\text{dBV}$	38	40	42	dB
OUTPUT STAGE						
Maximum Output Level	MPO	$V_{IN} = -20\text{dBV}$, $RMPO = 0\Omega$	-14.3	-12.3	-10.3	dBV
MPO Range	ΔMPO	$V_{IN} = -20\text{dBV}$, $RMPO = 0$ to $50\text{k}\Omega$	13.8	15.8	17.8	dB
Stage D Gain	A_D		-	16	-	dB
REGULATOR						
Regulator Voltage	V_{REG}		0.89	0.94	0.99	V

All parameters remain as shown in the Test Circuit unless otherwise stated in CONDITIONS column

Notes: 1. $A_{RANGE} = V_{P3}[V_{IN} = -97\text{dBV}] - V_{P3}[V_{IN} = -20\text{dBV}] + 77\text{dBV}$

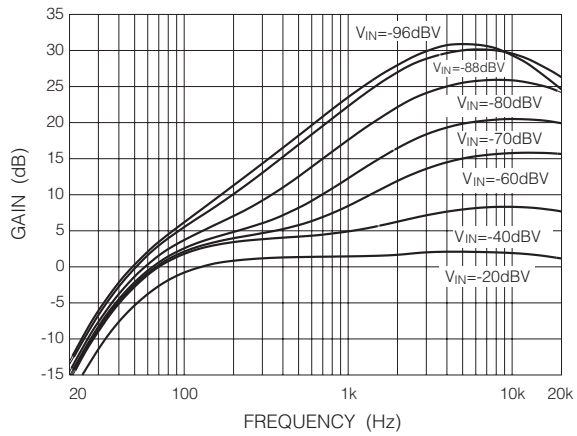

Fig. 5 Frequency Response for Different Input Levels

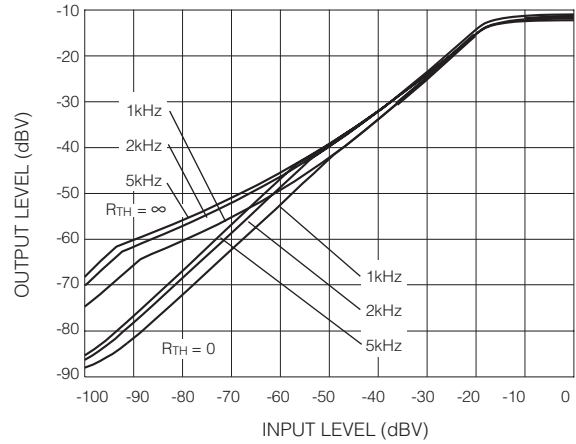

Fig. 6 I/O Transfer Function for Different Test Frequencies. Shown for Min/Max R_{TH} Resistors Values

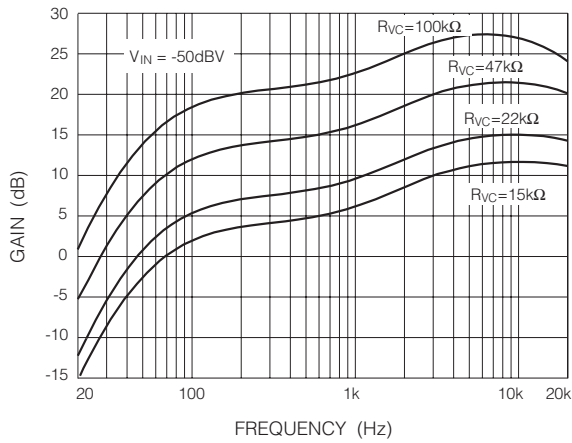

Fig. 7 Frequency Response for Different R_{VC} Values

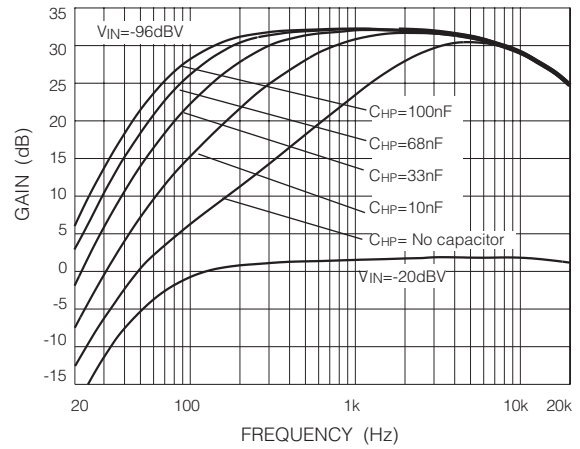

Fig. 8 Corner Frequency vs C_{HP} Capacitor Value

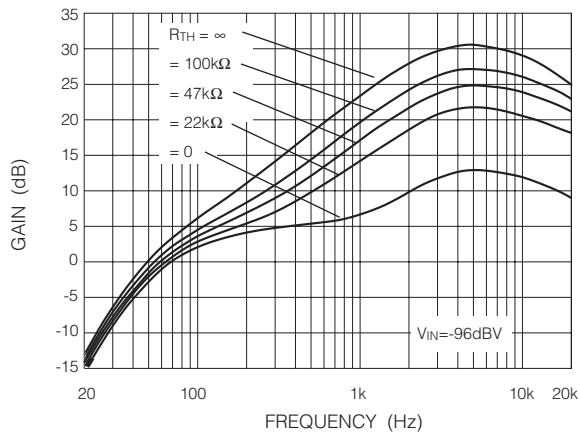

Fig. 9 Frequency Characteristics for Different R_{TH} Values

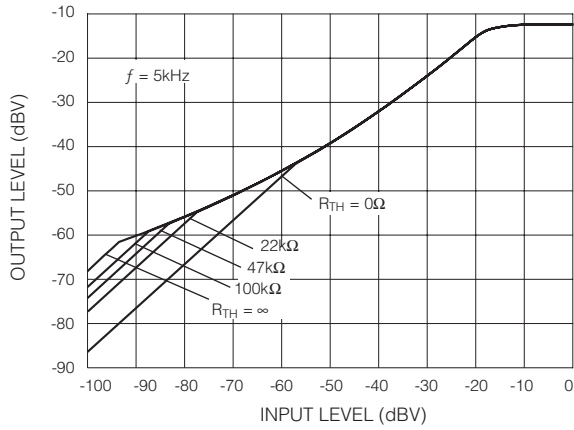

Fig. 10 I/O Transfer Function for Different R_{TH} Resistors

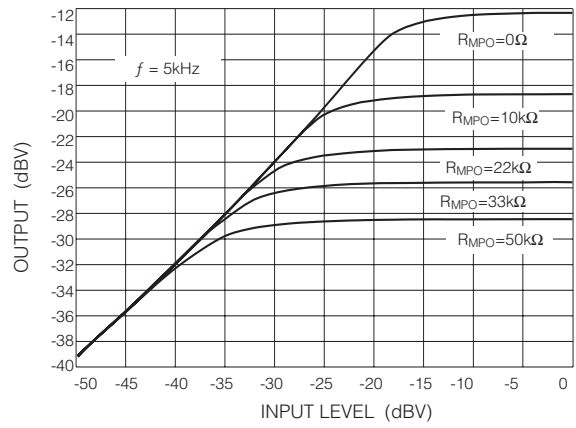

Fig. 11 I/O for Various R_{MPO} Settings

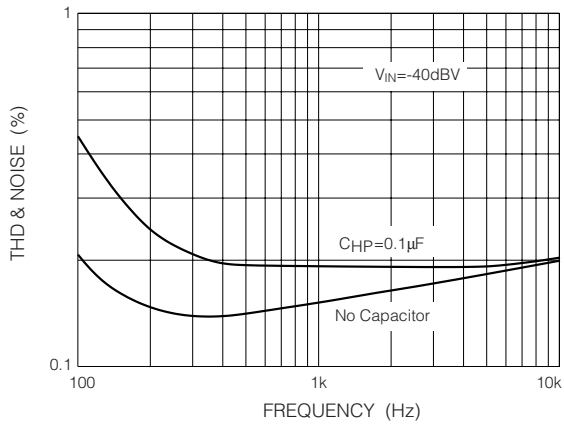

Fig. 12 THD & Noise vs Frequency

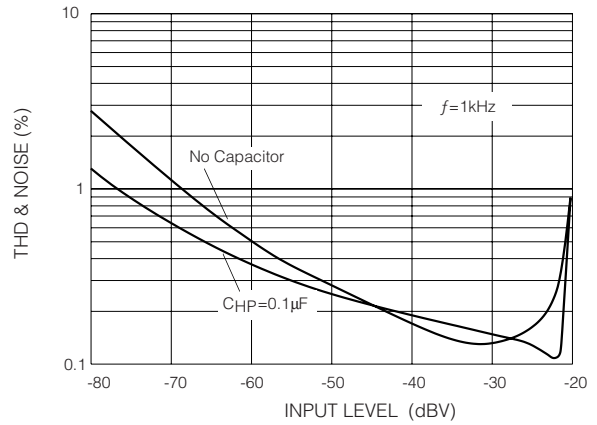

Fig. 13 THD & Noise vs Input Level

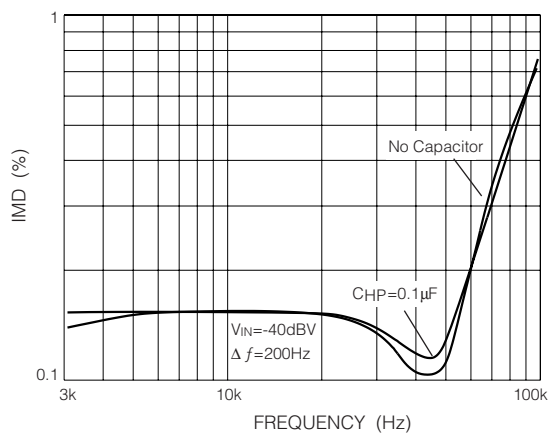

Fig. 14 Intermodulation Distortion (CCIF) vs Frequency

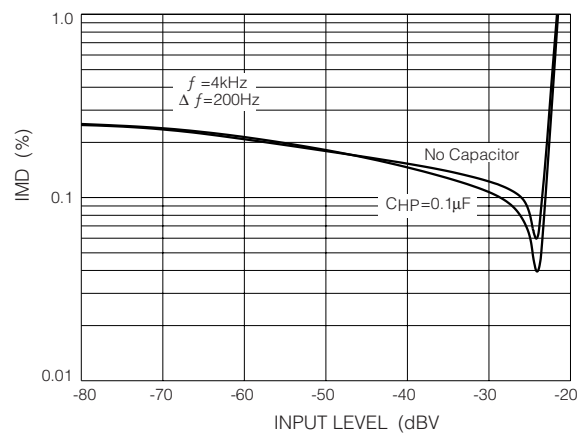
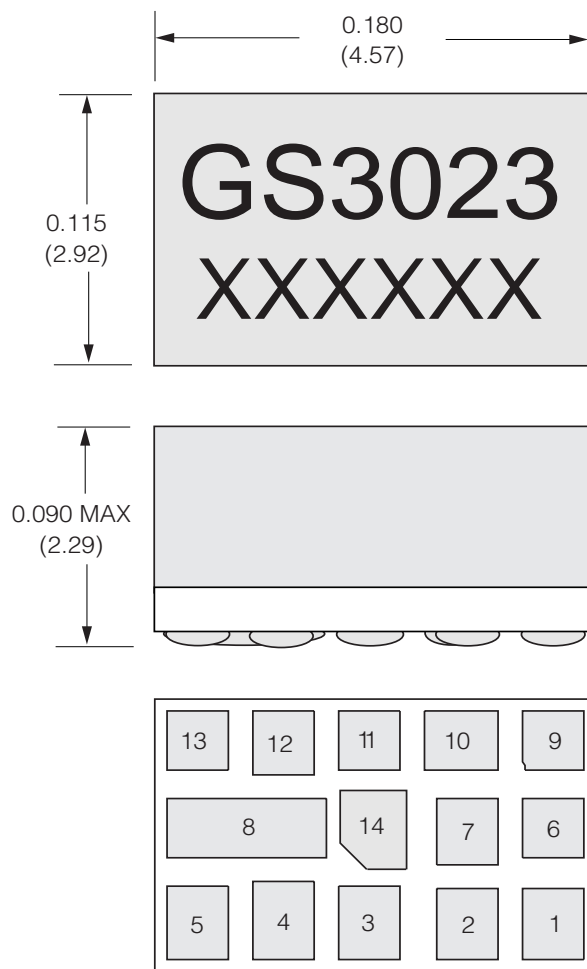

Fig. 15 Intermodulation Distortion (CCIF) vs Level



Dimension units are in inches.
 Dimensions in parenthesis are in millimetres converted from inches and include minor rounding errors.
 1.0000 inches = 25.400 mm.
 Dimension ± 0.005 (+0.13) unless otherwise stated.
 Pad numbers for illustration purposes only.
 Smallest pad 0.025 x 0.025 (0.64 x 0.64)
 Largest pad 0.025 x 0.065 (0.64 x 1.65)
 XXXXXX - work order number.
 This hybrid is designed for point to point soldering.

Fig. 16 Hybrid Layout & Dimensions

DOCUMENT IDENTIFICATION: DATA SHEET
 The product is in production. Genum reserves the right to make changes at any time to improve reliability, function or design, in order to provide the best product possible.

REVISION NOTES:
 Updated to Data sheet